

**ALUMINIUM SINGLE ACTING CYLINDERS,
HOLLOW PISTON, SPRING RETURN****LARZEP advantages**

- Lightweight hollow cylinders from 22 to 100 Tn and up to 250 mm stroke.
- Made out of high strength aluminium alloy.
- Hollow piston, spring return.
- All aluminium parts are treated to improve resistance and extend working life.
- Fitted with steel base plate and saddle for wear resistance.
- 40% weight reduction when compared with steel equivalent.
- Hollow plain saddle as standard.
- Not suitable for high cycle applications.

**Strand jacks and Post tensioning
available upon request.**



Carefully read and understand the safety instructions.



HOLLOW PISTON ALUM. CYL.



SAH

22-150 Tn.

700 bar

CYLINDERS



Aluminium Double Acting Hollow Piston Cylinders DAH.

Page. 66

Larzep designs and manufactures special cylinders and fixing systems upon request.





Single Acting Hand Pumps, W.

Page. 80



Air Hydraulic Pumps, Z, ZR.

Page. 82

Carefully read and understand the safety instructions.



Hoses.

Page. 106

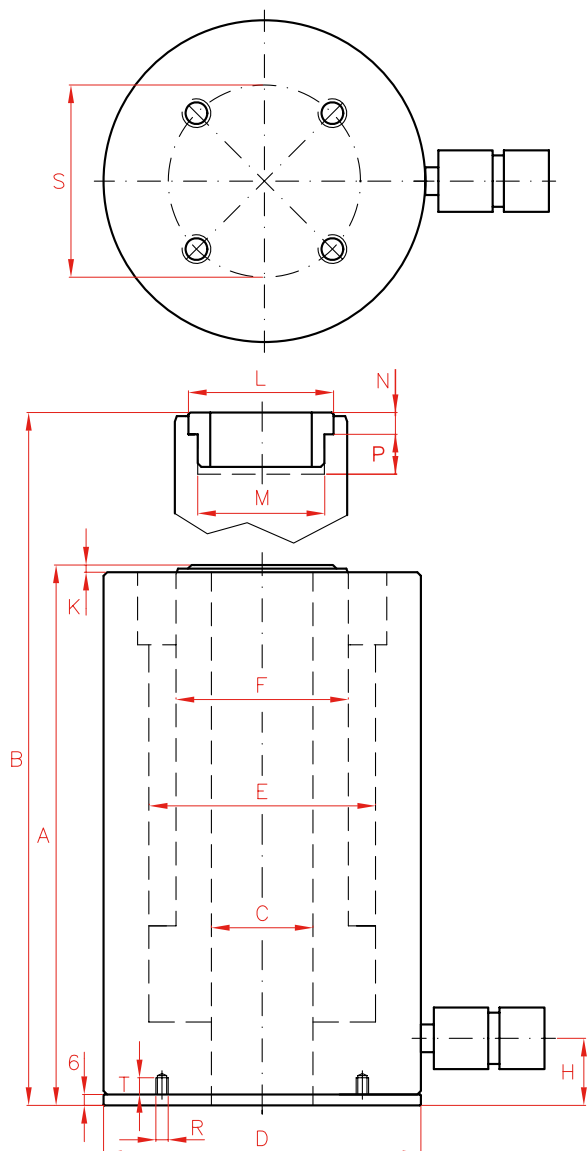

Capacity		Stroke	Model	Oil Cap.	A
Tn	kN	mm	LARZEP	cm ³	mm
22	217	50	SAH02205	158	183
		100	SAH02210	316	253
		150	SAH02215	474	323
		200	SAH02220	632	383
		250	SAH02225	790	448
30	302	50	SAH03005	220	210
		100	SAH03010	440	278
		150	SAH03015	660	352
		200	SAH03020	880	410
		250	SAH03025	1.100	475
60	578	50	SAH06005	421	243
		100	SAH06010	842	298
		150	SAH06015	1.263	363
		200	SAH06020	1.684	428
		250	SAH06025	2.105	493
100	1.018	50	SAH10005	742	260
		100	SAH10010	1.484	327
		150	SAH10015	2.226	397
		200	SAH10020	3.968	462
		250	SAH10025	3.710	532
150	1.407	50	SAH15005	1.025	291
		100	SAH15010	2.049	366
		150	SAH15015	3.074	441
		200	SAH15020	4.098	511
		250	SAH15025	5.123	589



Interchangeable Saddles.

Page. 112



Quick Couplers.

Page. 108



Pressure Gauges.

Page. 116



Coupler 3/8"-18 NPT included.

Page. 108

	B	C	D	E	F	H	K	L	M	N	P	R	S	T	Area	Weight	Model
	mm	mm	mm	mm	mm	mm	mm	mm	UN	mm	mm		mm	mm	cm ²	kg	LARZEP
	233	27	100	75	56	26	3	48	1 9/16"-16	8	20	M6	85	19	32	4,5	SAH02205
	353	27	100	75	56	26	3	48	1 9/16"-16	8	20	M6	85	19	32	5,8	SAH02210
	473	27	100	75	56	26	3	48	1 9/16"-16	8	20	M6	85	19	32	7,0	SAH02215
	587	27	100	75	56	26	3	48	1 9/16"-16	8	20	M6	85	19	32	8,0	SAH02220
	698	27	100	75	56	26	3	48	1 9/16"-16	8	20	M6	85	19	32	8,8	SAH02225
	260	33	130	90	68	32	4	55	1 11/13"-16	9	22	M6	110	19	44	7,5	SAH03005
	378	33	130	90	68	32	4	55	1 11/13"-16	9	22	M6	110	19	44	10,0	SAH03010
	502	33	130	90	68	32	4	55	1 11/13"-16	9	22	M6	110	19	44	11,5	SAH03015
	610	33	130	90	68	32	4	55	1 11/13"-16	9	22	M6	110	19	44	13,0	SAH03020
	725	33	130	90	68	32	4	55	1 11/13"-16	9	22	M6	110	19	44	14,6	SAH03025
	293	56	175	125	95	37	4	80	2 3/4"-16	12	22	M6	155	19	84	16,3	SAH06005
	398	56	175	125	95	37	4	80	2 3/4"-16	12	22	M6	155	19	84	19,5	SAH06010
	513	56	175	125	95	37	4	80	2 3/4"-16	12	22	M6	155	19	84	23,4	SAH06015
	628	56	175	125	95	37	4	80	2 3/4"-16	12	22	M6	155	19	84	26,0	SAH06020
	743	56	175	125	95	37	4	80	2 3/4"-16	12	22	M6	155	19	84	32,0	SAH06025
	310	81	235	170	130	40	6	116	4"-16	13	25	M6	215	19	148	31,0	SAH10005
	427	81	235	170	130	40	6	116	4"-16	13	25	M6	215	19	148	38,0	SAH10010
	547	81	235	170	130	40	6	116	4"-16	13	25	M6	215	19	148	45,0	SAH10015
	662	81	235	170	130	40	6	116	4"-16	13	25	M6	215	19	148	53,0	SAH10020
	782	81	235	170	130	40	6	116	4"-16	13	25	M6	215	19	148	61,0	SAH10025
	341	81	260	190	150	61	10	135	4 1/4"-12	20	40	M6	220	19	205	43,0	SAH15005
	466	81	260	190	150	61	10	135	4 1/4"-12	20	40	M6	220	19	205	54,0	SAH15010
	591	81	260	190	150	61	10	135	4 1/4"-12	20	40	M6	220	19	205	61,0	SAH15015
	711	81	260	190	150	61	10	135	4 1/4"-12	20	40	M6	220	19	205	76,0	SAH15020
	839	81	260	190	150	61	10	135	4 1/4"-12	20	40	M6	220	19	205	87,0	SAH15025